

~~PARSONS 5153 807/0081~~

8900B PEAK POWER CALIBRATOR

OPERATING AND SERVICE MANUAL



HEWLETT  PACKARD





CERTIFICATION

The Hewlett-Packard Company certifies that this instrument was thoroughly tested and inspected and found to meet its published specifications when it was shipped from the factory. The Hewlett-Packard Company further certifies that its calibration measurements are traceable to the U.S. National Bureau of Standards to the extent allowed by the Bureau's calibration facility.

WARRANTY AND ASSISTANCE

All Hewlett-Packard products are warranted against defects in materials and workmanship. This warranty applies for one year from the date of delivery, or, in the case of certain major components listed in the operating manual, for the specified period. We will repair or replace products which prove to be defective during the warranty period. No other warranty is expressed or implied. We are not liable for consequential damages.

For any assistance contact your nearest Hewlett-Packard Sales and Service Office. Addresses are provided at the back of this manual.

OPERATING AND SERVICE MANUAL

MODEL 8900B
PEAK POWER CALIBRATOR

SERIALS PREFIXED: 623 -

This manual covers all 8900B Peak Power Calibrators with three -digit serial numbers and eight-digit serial numbers with 623 prefixes.

Copyright HEWLETT-PACKARD COMPANY 1966
GREEN POND ROAD, ROCKAWAY, NEW JERSEY, U.S.A.

TABLE OF CONTENTS

Section	Page	Section	Page
I. GENERAL INFORMATION	1-1	4-7. Description of Operation	4-1
1-1. Introduction	1-1	4-12. Monitor Output	4-2
1-5. Instrument Identification	1-1		
II. INSTALLATION	2-1	V. MAINTENANCE	5-1
2-1. Introduction	2-1	5-1. Introduction	5-1
2-3. Unpacking and Inspection	2-1	5-3. Performance Checks	5-1
2-5. Installation	2-1	5-5. Test Equipment Required	5-1
2-8. Ventilation	2-1	5-7. Troubleshooting and Repair	5-4
2-10. Power Requirements	2-1	5-9. Mechanical Disassembly Procedures	5-4
2-15. Repackaging for Shipment	2-1	5-10. Top and Bottom Covers	5-4
		5-11. Right and Left Side Covers	5-4
III. OPERATION	3-1	5-12. Meter	5-4
3-1. Introduction	3-1	5-13. RF Detector Diode	5-4
3-3. Controls and Indicators	3-1	5-14. Adjustment and Calibration	5-5
3-5. Operating Procedures	3-1	5-16. Power Supply	5-5
3-8. Measurement Procedure	3-1	5-17. Detector Diode Check	5-5
3-19. Using the DC Reference Output	3-2	5-19. Chopper Performance	5-5
3-23. Operational Guide	3-2	5-20. Power Level Calibration	5-5
3-25. Accuracy	3-2	VI. REPLACEABLE PARTS	6-1
3-30. Custom Calibration Chart	3-3	6-1. Introduction	6-1
3-33. Importance of the Oscilloscope	3-3	6-5. Ordering Information	6-1
3-35. Effect of 8900B Chopper on Oscilloscope Waveforms	3-3	VII. MAINTENANCE DATA	7-1
3-37. Monitor Output	3-4	7-1. Introduction	7-1
IV. PRINCIPLES OF OPERATION	4-1	7-3. Printed Circuit Board Diagram	7-1
4-1. Definition of Peak Power	4-1	7-5. Detector Block Disassembly	7-1
4-4. Method of Measurement	4-1	7-7. Schematic	7-1

LIST OF ILLUSTRATIONS

Number	Title	Page
1-1.	8900B Peak Power Calibrator	1-1
2-1.	Rack Mounting Instructions	2-0
3-1.	Operating Controls and Layout	3-0
3-2.	Null Adjustment	3-1
3-3.	Pulse Measurement	3-2
3-4.	Typical Input VSWR	3-3
3-5.	Typical Custom Calibration Chart	3-3
3-6.	Typical Oscilloscope Display	3-3
3-7.	Typical Chopper Waveform	3-3
3-8.	Effect of Contact Bounce	3-4
3-9.	Modulating Signal Frequency Response	3-4
4-1.	8900B Block Diagram	4-1
5-1.	Path Attenuation Check	5-2
5-2.	Calibration Check	5-2
5-3.	RF Detector Diode Assembly	5-4
5-4.	Detector Diode Check Setup	5-5
5-5.	Chopper Performance	5-5

Number	Title	Page
5-6.	Path Attenuation	5-6
5-7.	Meter Calibration Setup	5-6
6-1.	8900B Top View	6-3
6-2.	8900B Bottom View	6-3
7-1.	Printed Circuit Board Assembly	7-2
7-2.	Detector Block Disassembly	7-3
7-3.	Schematic Diagram - 8900B	7-3

LIST OF TABLES

Number	Title	Page
1-1.	Specifications	1-0
3-1.	Attenuation Requirements	3-1
5-1.	Recommended Equipment List	5-1
5-2.	Performance Checks	5-2
6-1.	Reference Designation Index	6-2
6-2.	Replaceable Parts	6-4

RF CHARACTERISTICS

RF range: 50 to 2000 MHz.

RF power range: 10 to 200 mw; may be increased through use of external attenuators or directional couplers.

RF power accuracy: ± 1.5 db (± 0.6 db with custom calibration curve.)

RF power precision: 0.1 db.

RF pulse width: > 0.25 μ sec.

Pulse repetition rate: 1.5 MHz maximum.

RF impedance: 50 ohms.

RF VSWR: < 1.25 .

MONITOR OUTPUT

Level: 0.2 v for 20 mw input.

Impedance: 150 ohms nominal.

Bandwidth: 1 kHz to 7 MHz.

POWER: 105 to 125 v or 210 to 250 v, 50 to 60 Hz.

AUXILIARY EQUIPMENT REQUIRED: -hp-140A Oscilloscope or equivalent.

WEIGHT: net: 10 lbs. (4,5 kg); shipping: 13 lbs. (5,9 kg).

DIMENSIONS:

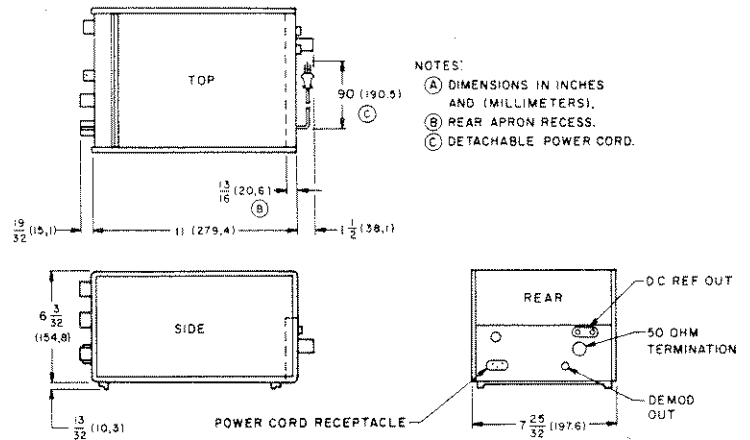

Table 1-1. Specifications

SECTION I

GENERAL INFORMATION

1-1. INTRODUCTION

1-2. The 8900B Peak Power Calibrator provides a convenient means for measuring the peak RF power of pulses in the range of 50 to 2000 MHz. The power level is read out directly on the panel meter and is independent of repetition rate (less than 1.5 MHz) and pulse width (greater than $0.25 \mu\text{sec}$).

1-3. In operation, the 8900B provides the circuitry to compare an internal standardized dc reference level with the demodulated RF pulses. The comparison is done visually on an oscilloscope. The meter actually reads out the variable dc reference level in terms of milliwatts.

1-4. Complete specifications for the 8900B are given

in Table 1-1.

1-5. INSTRUMENT IDENTIFICATION.

1-6. Hewlett-Packard uses a two-section, eight-digit serial number (on instrument rear panel) to identify instruments (000-00000). The first three digits are a serial prefix number, and the last five digits refer to a specific instrument. If the serial prefix on your instrument does not appear on the title page of this manual, there are differences between the manual and your instrument which are described in the Appendix or in a Manual Change Sheet included with the manual. If the change sheet is missing, the information can be supplied by your local sales office.

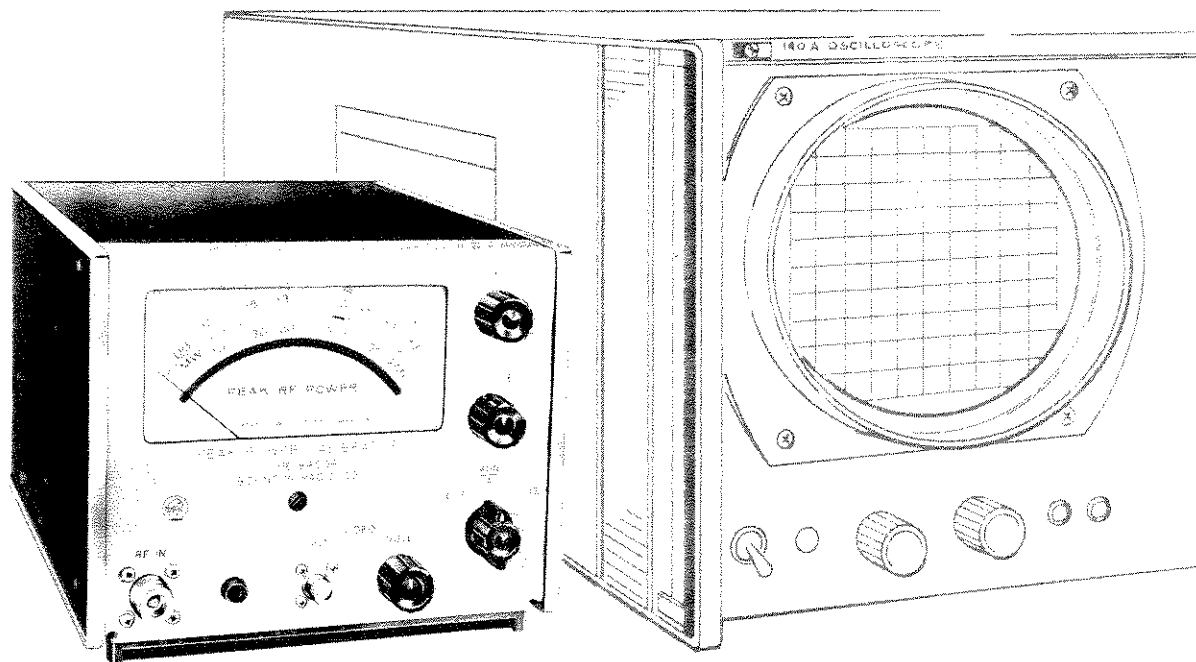

Figure 1-1. 8900B Peak Power Calibrator

Figure 2-1

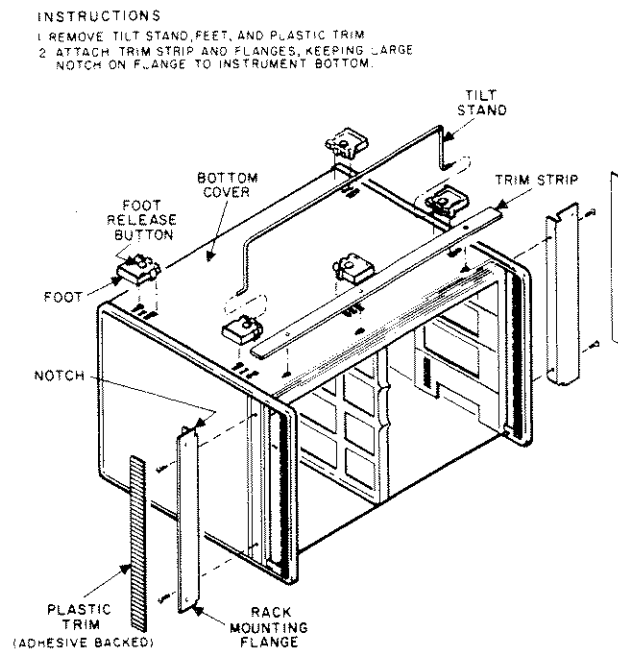

Figure 2-1. Rack Mounting Instrument

SECTION II

INSTALLATION

2-1. INTRODUCTION

2-2. This section contains information on unpacking, inspection, repacking and installation.

2-3. UNPACKING AND INSPECTION.

2-4. Inspect instrument for shipping damage as soon as it is unpacked. Check for broken knobs and connectors; inspect cabinet and panel surfaces for dents and scratches. If instrument is damaged in any way or fails to operate properly, notify carrier immediately (see warranty statement on the inside front cover of this manual). For assistance of any kind, including help with instruments under warranty, contact your Hewlett-Packard field office.

2-5. INSTALLATION

2-6. This instrument may be rack mounted after installation in a combining case (-hp- 1052A) or a rack adapter frame (-hp- 5060-0797). (See figure 2-1). The area not used by the instrument, in either case, may be covered by a filler panel (-hp- 5060-0794). When rack mounting this instrument, special provision must be made for access to the MON OUT and DC REF OUT connections which are mounted on the rear panel of the instrument.

2-7. Connect the power cord to the power socket on the rear panel of the 8900B.

2-8. VENTILATION

2-9. The 8900B utilizes solid state circuitry. Heat is dissipated through conduction and radiation. This instrument has been tested to operate satisfactorily in ambient temperatures up to 55° C (131° F). Ventilation should be provided to avoid exceeding this temperature.

2-10. POWER REQUIREMENTS

2-11. The model 8900B can be operated from a 115 or 230 v $\pm 10\%$, 50 to 60 Hz source. An input voltage switch (115v-230v) at the rear of the instrument selects the AC operation mode. A 3/10 amp fuse in the AC line is used for 115 v operation; a 15/100 amp fuse for 230 v operation.

2-12. THREE-CONDUCTOR POWER CABLE.

2-13. To protect operating personnel, the National Electrical Manufacturers' Association (NEMA) recommends that the instrument panel and cabinet be grounded. All Hewlett-Packard instruments are equipped with a three-conductor power cable which, when plugged into an appropriate receptacle, grounds the instruments. The offset pin on the power cable three-prong connector is the ground wire.

2-14. To preserve the protection feature when operating the instrument from a two-contact outlet, use a three-prong to two-prong adapter and connect the green pigtail on the adapter to ground.

2-15. REPACKAGING FOR SHIPMENT

2-16. The following is a general guide for repackaging for shipment. If you have any questions, contact your local -hp- Sales and Service Office (see lists at rear of this manual).

a. Place instrument in original container if available. If original container is not available, it can be purchased from your nearest -hp- Sales and Service Office.

If original container is not used:

b. Wrap instrument in heavy paper or plastic before placing in an inner container.

c. Use plenty of packing material around all sides of instrument and protect panel faces with cardboard strips.

d. Place instrument and inner container in a heavy carton or wooden box and seal with strong tape or metal bands.

e. Mark shipping container with "Delicate Instrument", "Fragile", etc.

NOTE: If the instrument is to be shipped to Hewlett-Packard for service or repair, attach to the instrument a tag identifying the owner and indicate the service or repair to be accomplished; include the model number and serial number of the instrument. In any correspondence, identify the model and serial numbers.

Figure 3-1

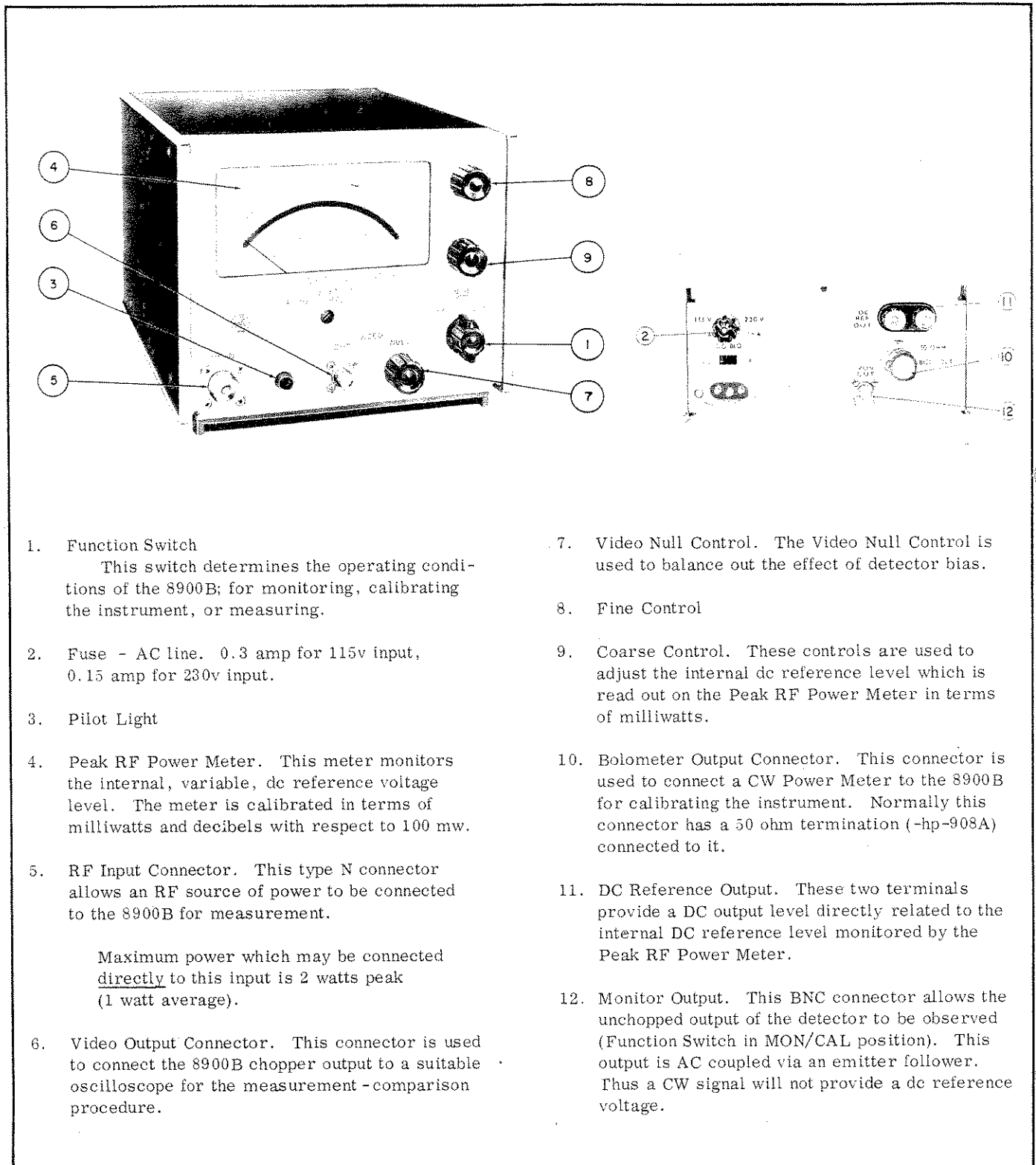

1. **Function Switch**
This switch determines the operating conditions of the 8900B; for monitoring, calibrating the instrument, or measuring.
2. **Fuse - AC line.** 0.3 amp for 115v input, 0.15 amp for 230v input.
3. **Pilot Light**
4. **Peak RF Power Meter.** This meter monitors the internal, variable, dc reference voltage level. The meter is calibrated in terms of milliwatts and decibels with respect to 100 mw.
5. **RF Input Connector.** This type N connector allows an RF source of power to be connected to the 8900B for measurement.

Maximum power which may be connected directly to this input is 2 watts peak (1 watt average).
6. **Video Output Connector.** This connector is used to connect the 8900B chopper output to a suitable oscilloscope for the measurement-comparison procedure.
7. **Video Null Control.** The Video Null Control is used to balance out the effect of detector bias.
8. **Fine Control**
9. **Coarse Control.** These controls are used to adjust the internal dc reference level which is read out on the Peak RF Power Meter in terms of milliwatts.
10. **Bolometer Output Connector.** This connector is used to connect a CW Power Meter to the 8900B for calibrating the instrument. Normally this connector has a 50 ohm termination (-hp-908A) connected to it.
11. **DC Reference Output.** These two terminals provide a DC output level directly related to the internal DC reference level monitored by the Peak RF Power Meter.
12. **Monitor Output.** This BNC connector allows the unchopped output of the detector to be observed (Function Switch in MON/CAL position). This output is AC coupled via an emitter follower. Thus a CW signal will not provide a dc reference voltage.

Figure 3-1. Operating Controls and Layout

SECTION III OPERATION

3-1. INTRODUCTION

3-2. The 8900B Peak Power Calibrator provides a simple means of measuring the peak power of pulsed RF in the 50 to 2000 MHz frequency range. The internal circuitry provides a calibrated dc level which is read on the front panel meter in terms of milliwatts and db. An internal detector demodulates the pulsed RF input signal to be measured. An oscilloscope is used to compare the adjustable dc level and the demodulated pulses. The horizontal line representing the dc level is adjusted to coincide with the pulse peak to be measured. The 8900B front panel meter will indicate the peak power.

3-3. CONTROLS AND INDICATORS

3-4. Front and rear panel controls, indicators, and connectors are shown in Fig. 3-1. Each control, indicator and connector is identified by a number to key each to the identifying text below the photographs.

3-5. OPERATING PROCEDURES

3-6. With power connected to the 8900B (see paragraph 2-10 for power requirements) rotate the function to the MON/CAL position.

3-7. This instrument requires no warm-up time.

CAUTION: DO NOT exceed power input limit at front panel "RF IN" connector as specified on the meter (2 WATTS PEAK OR 1 WATT AVERAGE or damage WILL result. (See paragraph 3-12 and Table 3-1).

3-8. MEASUREMENT PROCEDURE

3-9. Connect an oscilloscope to the VIDEO OUT connector.

NOTE: The oscilloscope bandwidth required is dependent on the waveshape being measured. The vertical amplifier must be dc coupled. For optimum resolution use the highest practical vertical sensitivity on all oscilloscope displays.

3-10. Check to see that the 50-ohm termination (-hp- 908A) is properly connected at the BOL OUT connector on the rear panel.

3-11. Connect the source of RF pulse power to be measured to the RF IN connector on the front panel through a suitable attenuator or coupler, if required.

NOTES:

1. Attenuators or couplers should be selected to provide attenuation as shown in Table 3-1.

Attenuation	F. S. Watts	F. S. dbm
0 db	200 (mw)	+23
10 db	2	-33
20 db	20	-43
30 db	200	+53
40 db	2000	+63

Table 3-1. Attenuation Requirements

2. The attenuator calibration accuracy is directly additive to the basic power measuring accuracy of the 8900B. Precision pads of known accuracy should be used.

3. Set the Function Switch to the MON/CAL position. The pilot light should light (indicating power to the instrument) and the front panel meter pointer should indicate within the CAL marking on the meter scale. This operation confirms that the dc reference supply and meter movement are working satisfactorily.

3-12. With the source of RF pulse power to the 8900B turned OFF, and the oscilloscope set to "free run", adjust the VIDEO NULL control until the two horizontal lines, observed on the oscilloscope, are superimposed (See Fig. 3-2). This operation balances out the detector diode bias from the video waveform which might otherwise be read as RF power.

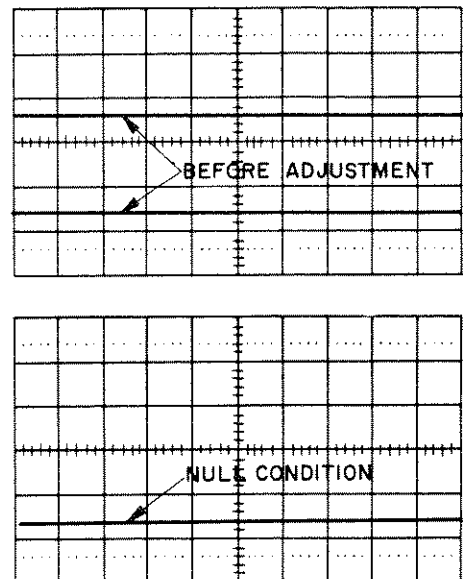

Figure 3-2. Null Adjustment

Paragraphs 3-13 to 3-28

3-13. Turn ON the source of RF power to the 8900B.

3-14. Set the Function Switch to the MEAS position.

3-15. With the oscilloscope dc coupled, synchronize the sweep, if possible, from the pulse source with the sweep time set to provide optimum visual observation. If necessary, use the internal synchronization of the oscilloscope.

3-16. Using the COARSE and FINE controls, adjust the dc reference voltage until the adjustable horizontal line coincides with the peak of the pulse as displayed on the oscilloscope (See Fig. 3-3).

NOTE: For optimum resolution, use the highest practical oscilloscope vertical sensitivity. Keep the trace in view with the vertical position control.

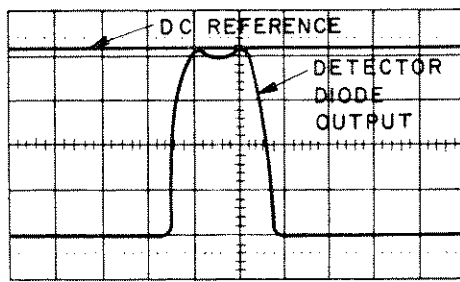

Figure 3-3. Pulse Measurement

3-17. Read the peak power on the front panel meter. If external attenuation is used, determine actual peak power using Table 3-1.

NOTE: The reading observed on the meter is accurate within ± 1.5 db. This reading may be applied to the Custom Calibration Chart (Fig. 3-4), furnished as an accessory with the 8900B, for a peak power accuracy of ± 0.6 db. These accuracies are based on absolute worst case errors.

3-18. The NULL control need not be adjusted for repetitive measurements.

3-19. USING THE DC REFERENCE OUTPUT

3-20. The DC REF OUT connector is provided to permit use of a chopping system operating at other than line frequency, if desired. For this operation it is necessary to deactivate the internal chopper and make a connection between the detector diode output and the VIDEO OUT connector. This is accomplished by removing the chopper (G1) and installing an octal plug with a jumper from PIN 7 to PIN 8. The external chopper can be connected with one arm to the DC REF OUT connector, and the selecting arm to an oscilloscope. If a dual trace oscilloscope is used, the external chopper may be eliminated by connecting the 8900B outputs (VIDEO OUT, DC REF OUT) to the

two vertical inputs of the oscilloscope with the vertical amplifiers set to the same sensitivity.

3-21. Another application of the DC REF OUT connector is the measurement of "one-shot" or non-repetitive waveforms. Plotting a curve of Peak RF Power Meter readings vs. DC REF OUT voltage produces a calibration of DC output in terms of Peak RF Power.

3-22. With this information, Peak RF Power of non-repetitive, or even repetitive, waveforms can be determined from visual records made with an oscilloscope camera.

3-23. OPERATIONAL GUIDE

3-24. In the practical application of the 8900B, the following information should assist in providing more accurate results as the capabilities and limitations of the instrument are expanded upon.

3-25. ACCURACY.

3-26. A basic objective of the 8900B is to provide a peak power measuring instrument of sufficient accuracy to serve as a working standard without the usual rigorous limitations of standards laboratory equipment. The high quality, forward biased diode is an order of magnitude more stable, environmentally, than an uncompensated bolometer or calorimeter.

3-27. While the specified accuracy of the Peak Power Calibrator is ± 0.6 db when using the Custom Calibration Chart, utilization to a higher degree of accuracy by virtue of its inherent stability, is both practical and recommended. The ± 0.6 db figure is based on absolute worst case error. It is also based on a minimum of standards equipment to perform a calibration. With high quality standards laboratory type equipment for calibration, operation to about ± 0.3 db worst case error is considered practical.

3-28. The worst case errors are contributed by the following.

- a. Measurement of the 16 db (normal) path attenuation from the RF IN connector to the CW standard output (BOL OUT) connector.
- b. Power Meter.
- c. Input VSWR reflection error. The typical input VSWR over the 8900B frequency range is shown in Fig. 3-5.
- d. Meter tracking and repeatability errors.
- e. Operator readout.
- f. Possible aging of the detector diode.

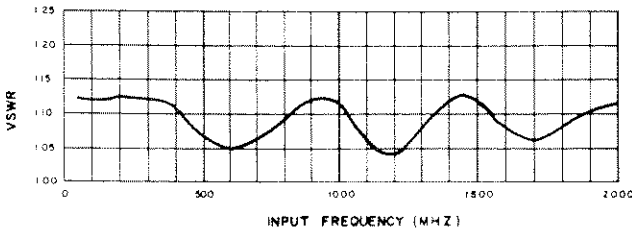

Figure 3-4. Typical Input VSWR

3-29. Reviewing the factors that can cause errors in the measurement, it can be seen that some items are more difficult to correct than others. However, by use of accurate standards laboratory quality instruments and observing the following suggestions, very accurate measurements can be made:

- a. Calibrate the 16 db (nominal) attenuation path to an accuracy of ± 0.1 db or better. (See par 5-22)
- b. Use a 1% or better CW power meter. (-hp-431C).
- c. Calibrate the instrument at the power level to be measured to eliminate meter tracking errors.
- d. Tune the input circuit to a VSWR of 1.00 to 1. The above steps should permit operation to a ± 0.3 db worst case error in the basic range of the instrument.

3-30. CUSTOM CALIBRATION CHART.

3-31. The Custom Calibration Chart (Fig. 3-5) supplies correction for errors attributable to the frequency sensitive components in the RF circuitry of the instrument. This chart information is obtained by maintaining a constant 100 mw (0 db) input to the Peak Power Calibrator and plotting the required meter correction over the frequency range as measurements are made.

3-32. The worst case errors due to frequency sensitivity add up to ± 0.7 db and are contributed by the following elements:

- a. The power divider.

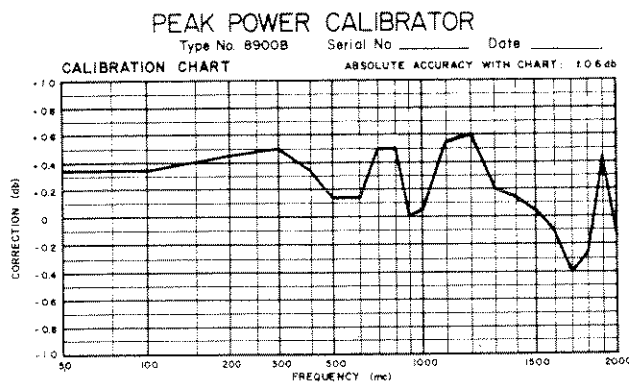

Figure 3-5. Typical Custom Calibration Chart

- b. The 10 db attenuator.
- c. The diode detector.
- d. Associated connectors.

3-33. IMPORTANCE OF THE OSCILLOSCOPE.

3-34. A basic factor in the philosophy of the 8900B is that of actual observation of the pulse waveform during the measurement. While this requires the use of a suitable auxiliary oscilloscope, it is considered important in the reduction of subtle errors: some of which are variations in pulse width, rate, or shape. It has an inherent advantage, in permitting measurement of intermediate levels of power in a complex waveshape. The operator may ignore characteristics, such as overshoot, if they contribute nothing to the effectiveness of his system, or he may measure them as he chooses. In some applications, the user may be monitoring the effectiveness of a system at the time the measurement is made in an effort to correlate system performance to peak RF power. It then becomes important that he verify that the output power has not changed by even a few tenths of a db at the time of the reading. A typical oscilloscope display from the 8900B during a measurement is shown in Figure 3-6.

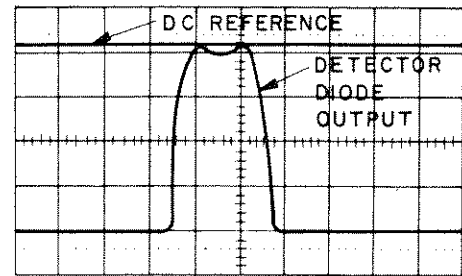

Figure 3-6. Typical Oscilloscope Display

3-35. EFFECT OF 8900B CHOPPER ON OSCILLOSCOPE WAVEFORMS.

3-36. The 60-cycle mechanical chopper effects the demodulated oscilloscope waveforms of some double pulsed RF signals and pulsed RF signals having a long duty cycle. This effect is caused by normal contact bounce. The decay time for the bounce sometimes approaches 600 μ secs. Figure 3-7 shows a typical chopper waveform. The effect of contact

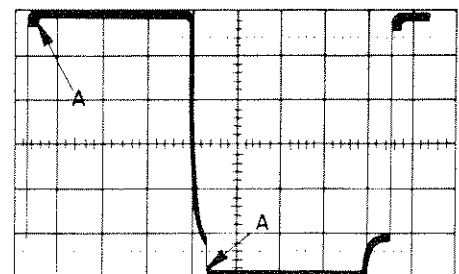

Figure 3-7. Typical Chopper Waveform

Paragraphs 3-38 to 3-39

bounce can be observed at points marked "A". During the measurement of a double pulsed RF signal the oscilloscope waveform will appear as shown in Fig. 3-8.

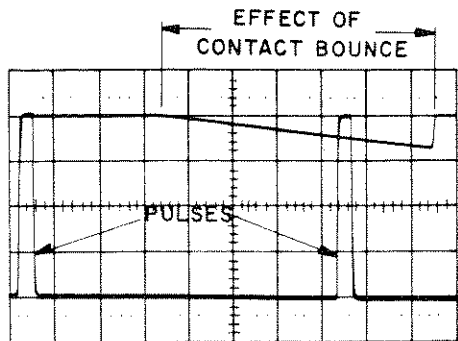

Figure 3-8. Effect of Contact Bounce

As a result of contact bounce, the db reference line will not be a straight line. When such a discontinuity resulting from contact bounce exists, several methods can be used to avoid incorrect measurements. The first method would be to synchronize the oscilloscope from the pulse video source. A second method is shown in Fig. 3-8 would be the use of a convenient oscilloscope graticule line as an extension of the correct dc reference line. Another method would involve experimenting with the internal horizontal sweep (when the sync from the pulse source is not

available) and the triggering of the sweep to obtain a straight dc reference line.

3-38. MONITOR OUTPUT.

3-39. A two-stage emitter follower isolating circuit connects the detector diode output to the rear panel Monitor Output connector (MON OUT) with an impedance of 150 ohms in the MON/CAL position of the function switch. This makes the detector output available for waveform monitoring or other purposes such as external oscilloscope synchronization. The bandwidth of 1 kHz to 7 MHz in the amplifier produces useful reproductions for a variety of pulse shapes. A typical frequency response of this circuit from the RF IN connector to the MON OUT connector is shown in Figure 3-9.

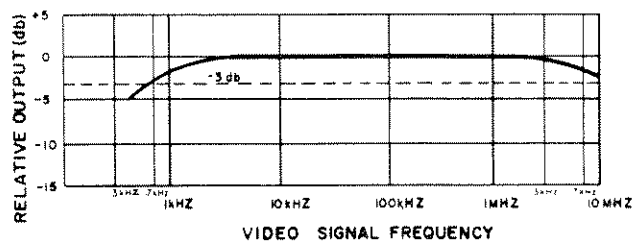

Figure 3-9. Modulating Signal Frequency Response

OPERATION

SECTION IV

4-1. DEFINITION OF PEAK POWER

4-2. The 8900B Peak Power Calibrator measures peak power as contrasted to average power measured by conventional bolometers and calorimeters. The relationship between peak and average power may be defined as follows:

$$P_{ave} = P_{peak} \times \text{Duty Cycle.}$$

4-3. Duty cycle is the fractional time a pulsed source is turned on. If the source were turned on 100% of the time, the duty cycle would be 1 and peak power and average power would be equal. Peak power, then, could be explained as the average power that would exist if the pulsed source were left on all the time. It is not the instantaneous peak power or envelope peak power that exists at the peak of the RF voltage waveform. Assuming a sinusoidal CW source with an average power of 1 watt, the peak power rating of the source is 1 watt also. If the source is turned off 50% of the time, the average power will be 1/2 watt, whereas the peak power rating remains 1 watt.

4-4. METHOD OF MEASUREMENT

4-5. For a sinusoidal CW source it is generally agreed that:

$$P_{ave} = \frac{E_{rms}^2}{R_{out}} = \frac{(.707 E_{peak})^2}{R_{out}} = \frac{(E_{peak})^2}{2R_{out}}$$

4-6. The average power and peak power of a source are equal if the duty cycle is 1. The voltage waveforms, then, must be identical for the duration of time the source is turned on, assuming a system of constant characteristic impedance or R_o . The peak voltage of the CW mode will be the same as the peak voltage when the source is pulsed, even though this is not the parameter to be measured. It is, however a means of correlation between the two. Employing a device known as the peak detector, we have an element which will respond identically, for a duration of time, to both a CW and a pulsed source of the same power rating. While elements, such as a bolometer, may respond quite differently to the two, depending on the heating effect, the peak detector does not. This is the principle of the 8900B Peak Power Calibrator.

4-7. DESCRIPTION OF OPERATION

4-8. Figure 4-1 is a block diagram illustrating the basic operation of the 8900B. It can be seen that a signal applied to the front panel input connector is

sent through two paths by virtue of the power divider. In one path, the signal passes through a 10 db attenu-

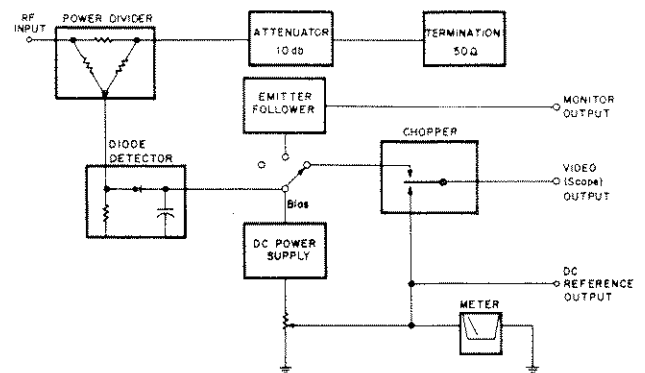

Figure 4-1. 8900B Block Diagram

ator and is absorbed in a 50-ohm termination. In the other path, the signal arrives at a diode peak detector which develops a dc level equal to the peak voltage of the RF waveform applied to it. The diode is forward biased to bring it to an operating point of maximum stability and to bring it away from the square-law region to produce a somewhat more linear change in output voltage for a change in the applied RF level. As the block diagram indicated, a variable dc supply is also included. The output of the supply is connected to a dc meter, which monitors its voltage, and to one leg of a mechanical chopper. If the chopper is set in operation and its selecting arm is connected to an oscilloscope, one can look first at the dc level produced by the peak detector in response to an RF voltage, and then at the dc level produced from the variable dc reference supply. In performing a measurement, the variable supply is adjusted until the two voltages are exactly equal. The dc meter monitoring the output of the variable supply is calibrated in terms of RF level required to produce a given dc from the peak detector, and hence, peak RF power can be read from it directly. CW power, of course, is correctly indicated also, since the calibration is in terms of the peak voltage waveform.

4-9. The design of the peak detector is an important factor in the reduction of errors. The output capacitor must be charged to the true peak of the waveform within the duration of the pulse, though not necessarily on the first cycle of the RF carrier. It may charge up in stair-case fashion over a period of several cycles, but must reach the peak before a measurement is made. The 8900B specification states that 0.25 μ sec. should be allowed for this, although

0.10 μ sec. is typical with a 6-foot length of RG-62/U (90 ohm) cable and an oscilloscope with 50 pf input capacitance connected to the video output. Since no isolating amplifier is employed, extremely high external capacitance could increase the time required for the video output to rise to the true peak of the voltage waveform. The impedance of the output circuit is approximately 350 ohms. The peak detector also has a responsibility to remain faithful at low RF carrier frequencies. It must not start to discharge while it is waiting for the crest of the next cycle of the RF voltage waveform to appear. If it falls by even a few per cent, the dc output level, within the duration of the pulse, would be lower than the true RF voltage peak and an error would be introduced. The 8900B was designed to meet its accuracy specification at carrier frequencies down to 50 MHz. The upper frequency limit is 2000 MHz. A front panel "NULL" control is included to permit the user to "erase" the static dc bias on the diode from the video presentation. While this control need not be reset for a repetitive series of measurements, it gives the operator a range of adjustment to compensate for any possible long-term aging effects on the diode. This adjustment is made with the Function Switch in the "MON/CAL" position.

4-10. In this position, also, a voltage divider from the reference power supply applies a preset voltage to the dc meter to deflect the needle to a calibration mark. It should be noted, however, that unlike some measuring systems, the reference supply is not really a critical parameter in the measurement because it is being used only for comparison rather

than as an absolute reference for the measurement. The meter calibration is the absolute reference.

4-11. Now consider the signal path which attenuates the incident power and dissipates the remainder in a 50-ohm load. This is provided as a convenient means of calibration or standardizing the instrument. If the 50-ohm load is replaced by an accurate CW power measuring device, such as a bolometer or calorimeter, and a CW source is connected to the input connector, the effect of the applied power level can be monitored on the average reading CW power meter and the peak reading diode detector simultaneously. Therefore, one need only to know accurately the attenuation between the front panel input connector and the power meter to determine what effect a known power level at the input has upon the peak RF detector. The 10 db pad is introduced to reduce the CW level to one within the range of several commercially available power meters. The CW source requirements are also met by readily available units.

4-12. MONITOR OUTPUT

4-13. The 8900B includes a two-stage emitter follower to provide an isolated monitor output for viewing and analyzing the demodulated output on an externally connected oscilloscope.

4-14. The output bandwidth is 1 kHz to 7 MHz permitting useful reproduction of a variety of waveforms. This output may also be used for synchronizing the oscilloscope sweep circuitry with Function Switch in the MON/CAL position.

SECTION V MAINTENANCE

5-1. INTRODUCTION

5-2. The 8900B Peak Power Calibrator is an easy instrument to maintain. All parts are accessible after removal of the top, bottom, and side covers. A plug-in circuit board containing most of the instrument circuitry is easily removal for the troubleshooting and repair.

5-3. PERFORMANCE CHECKS

5-4. The performance check in Table 5-2 verifies whether or not the 8900B is operating within the

specifications as stated in Table 1-1. This check may be used as part of an incoming quality control inspection, as a periodic operational check, or after repairs and/or adjustments have been made. The tests can be performed without instrument cover removal.

5-5. TEST EQUIPMENT REQUIRED.

5-6. The test instruments required to make the performance checks are listed in Table 5-1. Test instruments other than those listed may be used provided their specifications equal or exceed the critical specifications.

Table 5-1. Recommended Equipment List

Instrument Type	For	Critical Specifications	Recommended Instrument
Power Meter	Operation Performance Calibration	RF Range: 50 to 2000 MHz Power Range: 1 μ w to 10 mw Accuracy: 1%	-hp-431C with -hp-478A Thermistor Mount
Oscilloscope	Operation Performance Calibration	Frequency Range: 20 mc Sensitivity: .2v/cm	-hp-140A with 1402A and 1420A plug-ins
Pulse Generator	Performance	Pulse Width: 10 μ sec Repetition Rate: 10 kHz Output: 100 volts -negative going	-hp-214A
Electronic Voltmeter	Performance Calibration Troubleshooting	dc Range: to 300 v ac Range: to 300 v Accuracy: 2%	-hp-410C
High Output CW Source or Sources	Performance Calibration	RF Range: 50 to 2000 MHz Output: greater than 25 dbm (280 mw) 50-250 MHz 250-960 MHz 9-2 GHz	General Radio Type 1215B 1209B 1218A
Low Pass Filter	Performance Calibration	Depends on frequency of RF source	General Radio Type 874-F500 874-F1000 874-F2000L
Attenuators	Performance Calibration	Attenuation: 3 db 10 db (2 required) Accuracy: \pm 0.25 db	Weinschel Engineering Model 50-3N Model 50-10N
Double Female Type N Connector	Performance Calibration	Low VSWR	UG 29B/U
150 ohm Load	Performance	Can be assembled using a UG-88/U BNC connector and a 150 ohm, 10%, 1 watt carbon composition resistor	

Table 5-2

Table 5-2. Performance Checks

RF POWER ACCURACY

General. Power calibration is checked by first measuring the 8900B path attenuation. This is done at a power level within the normal measuring range of the instrument (+10 to +23 dbm). With an RF Power Meter (-hp-431C + +75A) replacing the rear-mounted 50-ohm termination (AT2), the CW incident power in dbm is determined by RF Power Meter reading + path attenuation.

Calibration and checking at 900 MHz is recommended, but a detailed performance evaluation would require checks at convenient frequency intervals between 50 MHz and 2 GHz.

A. Measure and record path attenuation.

1. Connect equipment as shown in Figure 5-1.

2. Set

8900B

Function Switch: MEAS

RF Source

Output frequency: 900 MHz

RF Power Meter

Range: -15 dbm

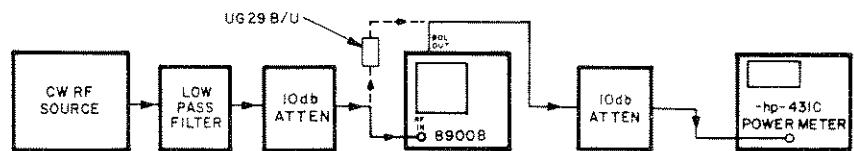

Figure 5-1. Path Attenuation Check

3. Adjust RF power level until RF Power Meter reads -16 dbm.

4. Disconnect 8900B (RF IN and BOL OUT) and replace it with a UG 29B/U Adapter. The Power Meter increase by approximately 16 db. Calculate exact change and record.

B. Check Calibration,

1. Connect equipment as shown in Figure 5-2.

2. Set

8900B

Function Switch: MEAS

Power Meter

Range Switch: +5 dbm

Oscilloscope

Vert Sens:

Horiz Sweep:

RF Source

RF Output: Zero or Off

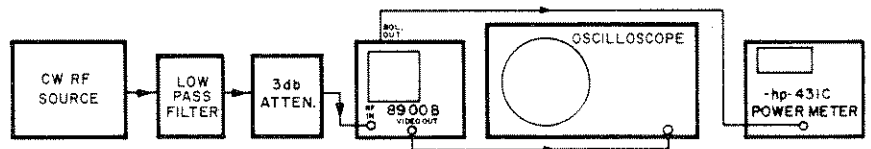

Figure 5-2. Calibration Check

3. Perform "Null" adjustment on 8900B (see paragraph 3-13)

4. Adjust RF Source output level so Power Meter reading added to path attenuation recorded in step A4 above is equal to 20 dbm. Power incident upon 8900B is then + 20 db or 100 mw.

5. Adjust 8900B COARSE and FINE controls for coincidence of oscilloscope traces

6. 8900B meter reading should be 100 mw \pm 1.5 db.

7. Reduce RF power level by 5 db and then 5 db more, each time adjusting the 8900B COARSE and FINE controls for oscilloscope trace coincidence. 8900B readings should be -5 \pm 1.5 db and -10 \pm 1.5 db, respectively.

NOTE: If a calibration check is to be made at more than one frequency, steps A1 through B7 must be repeated for each frequency.

If a custom calibration chart is supplied, the corrected readings must be accurate within \pm 0.6 db at all frequencies between 50 MHz and 2 GHz. A custom calibration is invalid after replacement of W1, Z1, AT1, Z2, or CR5.

Table 5-2. Performance Checks (Cont)

MONITOR OUTPUT
<ol style="list-style-type: none"> 1. Connect equipment as shown in Figure 5-2. 2. Set <u>8900B</u> Function Switch: MEAS COARSE and FINE controls: Adjust for 20 mw reading on Peak RF Meter <u>Pulse Generator</u> Pulse Amplitude: 100 volts, negative-going Repetition Rate: 10 kHz Pulse Width: 10 μsec Trigger: Internal <u>RF Source</u> Output Frequency: 900 MHz <u>Oscilloscope</u> Vertical Sensitivity: 50 mv/cm 3. Adjust level of RF source to 20 mw as determined by 8900B measurement. 4. Change 8900B Function Switch to MON/CAL position. 5. Change oscilloscope connection from 8900B VIDEO OUT to MON OUT connector and measure voltage level. The detected pulse level should be greater than 200 mv P-P for 20 mw input.
INPUT VSWR
<p>Input VSWR is measured with standard techniques. The only precaution that should be observed is that the power level used in the test should be between +10 and +22 dbm. The 50-ohm termination (AT2) should be installed for the test.</p> <p>Specification: Input VSWR should be less than 1 : 1.25.</p>
MONITOR OUTPUT BANDWIDTH
<ol style="list-style-type: none"> 1. Connect the Pulse Generator to the 8900B RF IN connector, and the oscilloscope (-hp- 140A + 1402A plug-in) to the MON OUT connector. 2. Apply a positive 2-volt pulse to the 8900B and measure the risetime on the oscilloscope. <p>Allowing for risetimes of pulse generator and oscilloscope, the specification bandwidth of the 8900B (7 MHz or greater) will result in a 0.053 μsec (or less) indicated risetime.</p> <p>Substitute test equipment will require recalculating the allowable indicated risetime.</p>

5-7. TROUBLESHOOTING AND REPAIR

5-8. The 8900B is a relatively simple instrument. For the purpose of troubleshooting, the 8900B schematic, Fig. 7-3, and the 8900B Print Circuit Board, Fig. 7-1, will have all necessary information including voltages and resistance readings where applicable. Voltmeter readings were made with an -hp-410C.

5-9. MECHANICAL DISASSEMBLY PROCEDURES

5-10. Top and Bottom Covers

- a. Remove two screws at rear of instrument.
- b. Slide cover toward rear of instrument to disengage lip at front panel.

5-11. Right and left Side Covers

- a. Remove screws from side covers. Top or bottom covers need not be removed to remove side covers.

5-12. Meter

- a. Remove top, bottom, right and left side covers.
- b. Remove all front panel knobs.
- c. Remove screws securing the RF IN and VIDEO OUT connectors.
- d. Remove all screws securing the side frames at the front of the instrument.
- e. Loosen all screws securing the side frames at the rear of the instrument.
- f. Spring side frames apart to allow front panel to drop forward.

NOTE: The pilot light wires will restrict movement.

- g. Remove wires from meter terminals.
- h. Remove four nuts securing meter to sub-panel and slide meter out of instrument.

5-13. RF Detector Diode (Fig. 5-3)

- a. Without removing the detector block from the instrument, loosen the socket head set-screw securing the diode with a No. 2 (.035") hex wrench.

NOTE: The printed circuit board must be removed to gain access to the diode set-screw.

- b. Lift out the diode.

- c. Remove the bowed washer (MPS) from the bottom pin of the diode.

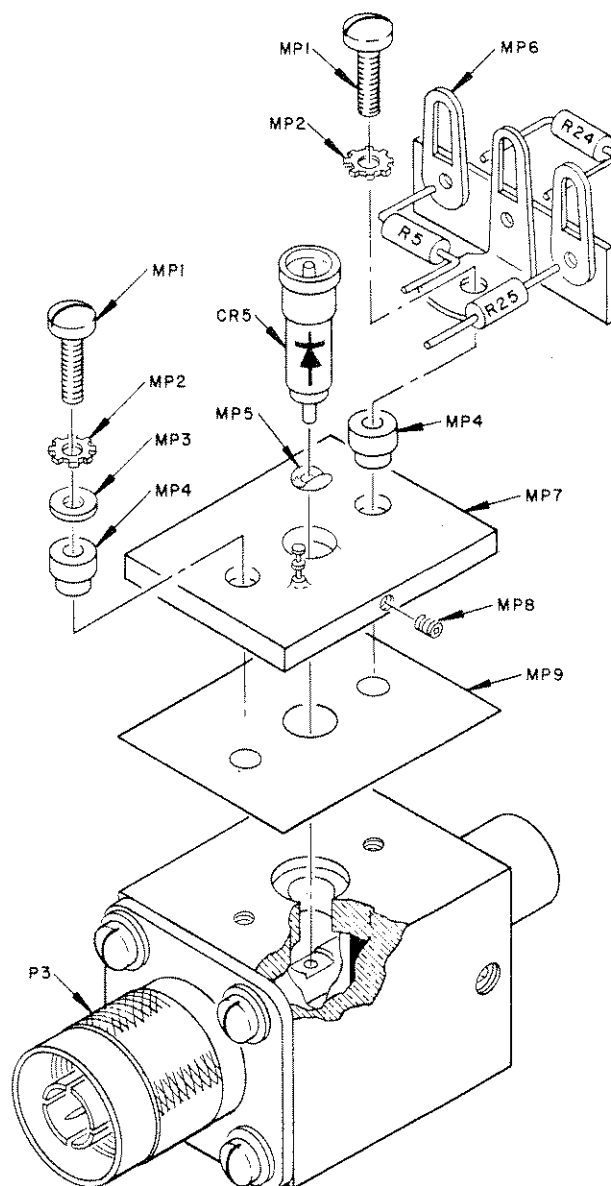

Figure 5-3. RF Detector Diode Assembly

(1) When replacing the diode, the cap must be on the cathode end of the diode. The bowed washer from the original diode should be placed (concave side up) on the anode end of the diode Fig. 5-5 Diode Replacement. It is important that the diode be pressed firmly in place before tightening the socket head setscrew.

5-14. ADJUSTMENT AND CALIBRATION

5-15. Adjustment procedures for the 8900B are given in Paragraphs 5-00 through 5-00.

Recommended test equipment for the adjustment procedure is listed in Table 5-1.

Do NOT perform the adjustments as a performance check. Test limits used in the adjustments should not be construed as part of the specifications.

5-16. Power Supply

- a. Connect an electronic voltmeter from positive side of C1 to negative side of C2. Voltage should be nominally 240 vdc.

CAUTION: The Electronic Voltmeter chassis must be ungrounded for the measurements in steps a and b.

- b. Measure voltage across CR6 (from TP1 to TP2). Voltage should be nominally 9.2 vdc.

- c. Measure voltage and ripple from TP3 to ground. Voltage should be nominally -11.5 vdc, with less than 20 mv p-p ripple at 125 vac line. If not, suspect CR7.

- d. Measure ripple between TP1 and ground. Ripple should not exceed 20 mv p-p at 125 vac line. If it does, suspect CR6.

- e. Connect the Electronic to the DC REF OUT terminals on the rear panel. With the FINE and NULL controls turned fully counter-clockwise, rotate the COARSE control through its full range. The dc meter should indicate from slightly negative to at least 1.4 v.

5-17. Detector Diode Check.

5-18. Diode damage may occur if input power levels exceed 1 watt average or 2 watts peak. The following procedure will check the condition of the diode:

- a. Connect the 8900B to a power source set to 115 vac.

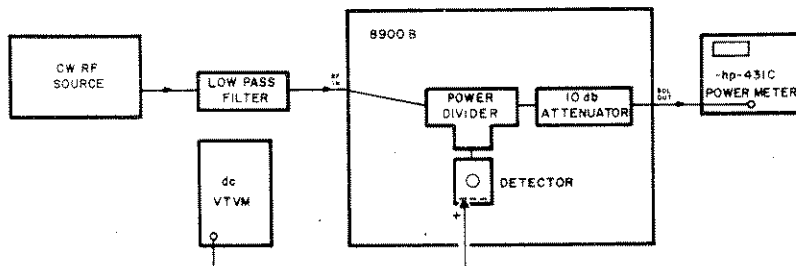

Figure 5-4. Detector Diode Check Setup

- b. Connect a dc electronic voltmeter to test point 5 (Figure 6-1 and 7-3)

(1) Voltage at test point 5 should be 0.27 ± 0.08 vdc.

NOTE: Voltage out of this range usually indicates a defective diode.

- c. Connect equipment as shown in Figure 5-4.

- d. Remove chopper, G1, from its socket.

- e. With the 8900B Function Switch in the OFF position, tune the RF Generator to 1 GHz and adjust the output level so the Power Meter indicates ± 1 dbm. 100 mw will then be applied to the RF IN connector.

- f. Measure the voltage at TP5, which should be nominally 1 vdc. A diode not measuring between 0.8 and 1.2 vdc should be replaced. (see Paragraph 5-13)

5-19. Chopper Performance

- a. Connect the oscilloscope to the VIDEO OUT connector on the Peak Power Calibrator. Synchronize the oscilloscope pattern at the chop-per frequency (50 or 60 cps) and adjust the COARSE control until a square wave (the chopper waveform) appears on the oscilloscope.

- b. Fig. 5-5 shows a typical oscilloscope pattern of the chopper operation. Duty cycle is approximately 50%. Contact bounce will generally increase with use. The chopper assembly (G-1) can be readily replaced if contact bounce becomes excessive and impairs observations on the oscilloscope.

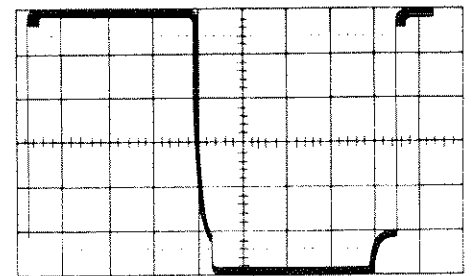

Figure 5-5. Chopper Performance

5-20. Power Level Calibration

5-21. Table 5-1 provides a list of Recommended Test Equipment for Performance Checks and Calibration over the full frequency range of the 8900B. RF Generator substitutions may be made, however, depending upon the 8900B application and available

Paragraphs 5-22 and 5-23 a through i

equipment. For example:

Frequencies below 500 MHz can be calibrated with power from an -hp-230A Power Amplifier driven by an -hp-3200B VHF Oscillator or an -hp-608 - series Signal Generator.

Frequencies from 1 to 2 GHz may be calibrated using power from the 8614A Signal Generator in combination with a 489A TWT Amplifier. This combination will allow checks and calibration at the frequencies used on DME/ATC Air Navigation equipment.

NOTE: With any type of RF Power Source, particular attention must be paid to the reduction of harmonics. Appropriate low-pass filters are usually necessary.

The following procedures will use 900 MHz, the optimum calibration frequency.

5-22. Path Attenuation Check

- a. Connect equipment as shown in Figure 5-6

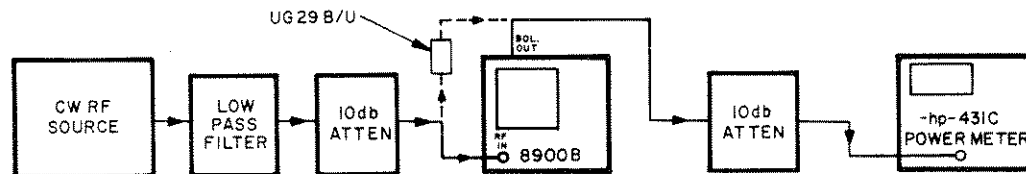

Figure 5-6. Path Attenuation Check Setup

- b. Set
8900B
 Function Switch: MEAS
RF Source
 Output frequency: 900 MHz
RF Power Meter
 Range: -15 dbm

- c. Adjust RF power level until RF Power Meter reads -16 dbm.
- d. Disconnect 8900B (RF IN and BOL OUT) and replace it with a UG 29B/U adapter. The power meter reading will increase by approximately 16 db. Calculate exact change and record.

5-23. Meter Calibration

- a. Connect the equipment as shown in Figure 5-7

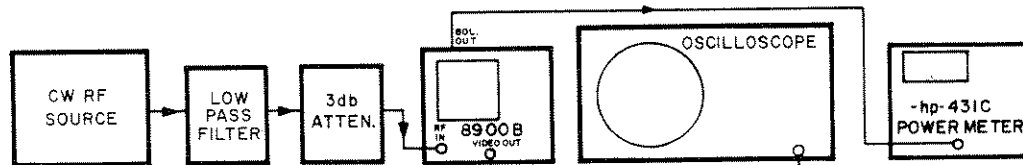

Figure 5-7. Meter Calibration Setup

- b. Adjust the RF Generator to 900 MHz and, without changing the frequency, turn the RF output off.
- c. Rotate the 8900B Function Switch to the CAL position.
- d. Set the oscilloscope vertical amplifier to direct coupling with the direct coupling with the sweep set to "free run".
- e. Adjust the 8900B NULL control until the two horizontal lines on the oscilloscope coincide. Use the highest oscilloscope vertical sensitivity practical for the most precise adjustment.
- f. Rotate the 8900B Function Switch to the MEAS position.
- g. Turn on the RF Generator and adjust the output level until the CW Power Meter reads 100 mw, minus the path attenuation determined for 900 MHz. The input at the 8900B RF IN connector is 100 mw.

EXAMPLE: If the path attenuation for the particular instrument checked measured 16.2 db at 900 MHz for 100 mw at the 8900B RF IN connector, the CW Power Meter should indicate 20 dbm — 16.2 db or +3.8 dbm, as indicated on the CW Power Meter. This will make the power at the 8900B RF IN connector exactly 100 mw.

h. Adjust the COARSE and FINE controls on the 8900B for 100 mw (0 db) reading on the RF Peak Power Meter.

i. At this point, the two horizontal lines should exactly coincide. If not, adjust R20.

NOTE: If balance cannot be attained, adjust R20 for minimum separation of the horizontal lines. Then, adjust the COARSE and FINE panel controls until the horizontal

lines coincide. Adjust R18 until the panel meter reads exactly 100 mw (0 db).

j. Verify the NULL adjustment by repeating steps e through b of the procedure.

k. Rotate the 8900B Function Switch to the MEAS position.

l. Turn the RF Generator on and reduce the power output, as indicated on the CW Power Meter, by exactly 10 db.

m. Adjust the COARSE and FINE controls on the 8900B until the two horizontal lines on the oscilloscope exactly coincide. The RF Peak Power Meter should read -10 db.

NOTE: If the meter does not read -10 db, note the error and readjust the COARSE and FINE controls until the meter reads exactly 0 db. Then, readjust R18 until the

meter indicates the same error (and in the same direction above or below 0 db) as it did at -10 db.

n. Increase the RF Generator output by exactly 10 db, as read on the CW Power Meter.

o. Repeat steps h through m until 0 db and -10 db read correctly.

p. Verify the NULL adjustment by repeating steps b through e of this procedure. If the NULL control is adjusted, repeat steps f through o.

q. Rotate the 8900B Function Switch to the MON/CAL position. Adjust the ac line voltage to 115 vac. Adjust R12 until the pointer falls within the calibration marking on the meter.

r. Tighten the locking nuts on the internal adjustable controls: R12, R18, and R20.

REFERENCE DESIGNATORS

AT	=	attenuator
C	=	capacitor
CR	=	diode
DS	=	lamp, indicator
F	=	fuse
G	=	chopper, mechanical
J	=	jack
M	=	meter
MP	=	mechanical part
P	=	plug
Q	=	transistor
R	=	resistor (fixed or variable)
S	=	switch
T	=	transformer
TP	=	test point
W	=	cable
Z	=	assembly

ABBREVIATIONS

A	=	ampere
AC	=	alternating current
C	=	capacitor
car flm	=	carbon film
comp	=	composition
db	=	decibel
dia	=	diameter
elect	=	electrolytic
fxd	=	fixed
gnd	=	ground
Hz	=	hertz
id	=	inside diameter
ins	=	insulated
lk	=	lock
lg	=	long
ma	=	milliampere
mach	=	machine
met flm	=	metal film
mw	=	milliwatt
my	=	mylar
od	=	outside diameter
p/o	=	part of
si	=	silicon
lhk	=	thick
v	=	volt
var	=	variable
w	=	watt
ww	=	wire wound
μ f	=	microfarad

SECTION VI REPLACEABLE PARTS

6-1. INTRODUCTION

6-2. This section contains information for ordering replacement parts. Table 6-1 lists parts in alpha-numerical order of their reference designations and indicates the description and -hp- stock number of each part, together with any applicable notes. Table 6-2 lists parts in alpha-numerical order by their -hp- stock number and provides the following information on each part:

- a. Description of the part (see list of abbreviations below).
- b. Typical manufacturer of the part in a five-digit code; see list of manufacturers in par 6-8.
- c. Manufacturer's part number.
- d. Total quantity used in the instrument (TQ column).

6-3. Miscellaneous mechanical parts are listed in Table 6-2.

6-4. For parts location and identification, see Fig. 6-1, 6-2; and 7-1.

6-5. ORDERING INFORMATION

6-6. To obtain replacement parts, address order or inquiry to your local Hewlett-Packard sales and service office (see lists at rear of this manual). Identify parts by Hewlett-Packard stock number.

6-7. To obtain a part not listed, include:

- a. Instrument model number
- b. Instrument serial number
- c. Description of part
- d. Function and location of parts

LIST OF MANUFACTURERS

<u>Code</u>	<u>Manufacturer</u>
01121	Allen Bradley Co.
01295	Texas Instrument, Inc.
04713	Motorola Semiconductor Products, Inc.
07115	Corning Glass Works, Electronic Comp. Dept.
07387	The Birtcher Corp.
12697	Clarostat Mfg. Co., Inc.
12749	James Electronics, Inc.
35434	Lectrohm, Inc.
42190	The Muter Co.
56289	Sprague Electric Co.
63743	Ward-Leonard Electric Co.
70903	Belden Mfg. Co.
71279	Cambridge Thermionic Corp.
71450	CTS Corporation
71785	Cinch Mfg. Co.
72765	Drake Mfg. Co.
75915	Littelfuse, Inc.
78553	Tinnerman Products, Inc.
80031	Mepco, Inc.
84411	TRW - Capacitor Div.
87930	Tower Mfg. Co.
91637	Dale Electronics, Inc.
93459	Weinschel Engineering Co., Inc.
95354	Methode Electronics Inc.
95712	Dage Electric Co., Inc.
96341	Microwave Associates, Inc.

Table 6-1

Table 6-1. Reference Designation Index

Reference Designation	Stock No.	Description	Note
AT1	0950-0114	Attenuator: fxd, 10db, Type N Connectors	
AT2	0950-0082	Termination: 50 ohms, Type N male connector (-hp- Model 908A)	
C1, 2	0180-1796	C: fxd, elect, 40 μ f, 150v	
C3		C: Special (Part of Z2)	
C4	0160-0741	C: fxd, my, .047 μ f, 10%, 100v	
C5, 6	0180-0258	C: fxd, elect, 10 μ f, 25v	
CR1-4	1901-0028	Diode, Si: 400v, 0.5A (1N1763 can be used for replacement)	
CR5	1900-0013	Detector, Diode (Part of Z2) (See paragraph 5-19)	
CR6	1902-0157	Diode, Zener: 8.9-9.7v, 10 ma, 1N2620	
CR7	1902-0158	Diode, Zener: 12.0v, 10%, 400 mw, 1N759	
DS1	1450-0048	Lamp, Indicator: Red, NE2H	
F1	2110-0044	Fuse: .3A, 250v, SLO-BLO (for 115v operation)	
	2110-0058	Fuse: .15A, 250v, SLO-BLO (for 230v operation)	
G1	0490-0122	Chopper: 6.3v, 50-60 Hz	
J1		Part of W2	
J2-4		Part of Z1	
J5		Part of AT1	
J6	1250-0192	Connector: BNC, UG-262/U	
J8	1510-0007	Binding Post: Red	
J9	1250-0192	Connector: BNC, UG-262/U	
J10	1510-0006	Binding Post: Black	
J11	1251-0135	Receptacle: Printed circuit board	
M1	1120-0167	Meter: PEAK RF POWER	
P2		Part of W2	
P3		Part of Z2	
P4		Part of AT1	
P5		Part of AT2	
P7	1251-0148	Connector: AC Power Cord Receptacle	
Q1, 2	1854-0006	Transistor: NPN, 2N706	
R1, 2	0692-8215	R: fxd, comp, 820 ohm, 5%, 2w	
R3	0692-4735	R: fxd, comp, 47K ohm, 5%, 2w	
R4	0686-6825	R: fxd, comp, 6.8K ohm, 5%, 1/2w	
R5	0686-4715	R: fxd, comp, 470 ohm, 5%, 1/2w	
R6	0724-0059	R: fxd, 60 ohm, 1%, 1/4w (Part of Z2)	
R7	0812-0060	R: fxd, ww, 5K ohm, 5%, 5w	
R8	0812-0059	R: fxd, ww, 6K ohm, 5%, 5w	
R9	0689-1025	R: fxd, comp, 1K ohm, 5%, 1w	
R10	2100-0764	R: var, ww, 50 ohm, 10%, 2w	
R11	0727-0937	R: fxd, car film, 3010 ohm, 1%, 1/2w	
R12	2100-0768	R: var, ww, 1.5K ohm, 5%, 2w	
R13	0686-6815	R: fxd, comp, 680 ohm, 5%, 1/2w	
R14	0686-1525	R: fxd, comp, 1.5K ohm, 5%, 1/2w	
R15, 16	2100-0767	R: var, ww, 500 ohm, 10%, 2w, dual	
R17	2100-0763	R: var, ww, 30 ohm, 10%, 3w	
R18	2100-0766	R: var, ww, 400 ohm, 5%, 2w	

Table 6-1. Reference Designation Index (Cont'd)

Reference Designation	Stock No.	Description	Note
R19	0727-0974	R: fxd, car flm, 1540 ohm, 1%, 1/2w	
R20	2100-0765	R: var, ww, 50 ohm, 5%, 2w	
R21-23	0727-0956	R: fxd, car flm, 40.91 ohm, 1%, 1/2w (P/o Z1)	
R24	0686-4715	R: fxd, comp, 470 ohm, 5%, 1/2w	
R25	0686-2215	R: fxd, comp, 220 ohm, 5%, 1/2w	
R26	0686-3335	R: fxd, comp, 33K ohm, 5%, 1/2w	
R27	0686-1835	R: fxd, comp, 18K ohm, 5%, 1/2w	
R28	0686-1035	R: fxd, comp, 10K ohm, 5%, 1/2w	
R29	0686-4725	R: fxd, comp, 4.7K ohm, 5%, 1/2w	
R30	0686-1025	R: fxd, comp, 1K ohm, 5%, 1/2w	
R31	0758-0006	R: fxd, met flm, 10K ohm, 5%, 1/2w	
S1		Switch: Power, P/o S3	
S2	3101-0033	Switch, Snap Slide	
S3A-C	3100-0762	Switch: 3 position, OFF-MON/CAL-MEAS	
T1	9100-0271	Transformer, Power	
W1	8120-0078	Power Cord	
W2	08900-60003	Cable Assembly (includes J1 & P2)	
Z1	08900-60007	Power Divider Assembly	
Z2	08900-60006	Detector Assembly	
Z2MP1	2295-0011	Screw, mach: #4-40 x 3/8" lg	
Z2MP2	2190-0071	Washer, Lk: #4, External	
Z2MP3	3050-0258	Washer, Flat: 1/4" od x .119" id x .025" thk	
Z2MP4	5020-2204	Washer: Shoulder	
Z2MP5	08900-00003	Washer, Spring: Bowed	
Z2MP6	0360-0364	Terminal Strip: 2 Ins, 1 Gnd	
Z2MP7	08900-60010	Plate & Eyelet Assembly	
Z2MP8	3030-0089	Screw, Set: #1-72 x 1/8" lg	
Z2MP9	08900-20001	Insulator, Detector (P/o C3)	
Z3	08900-60204	Printed Circuit Board Assembly	

Table 6-1, Figure 6-1 and 6-2

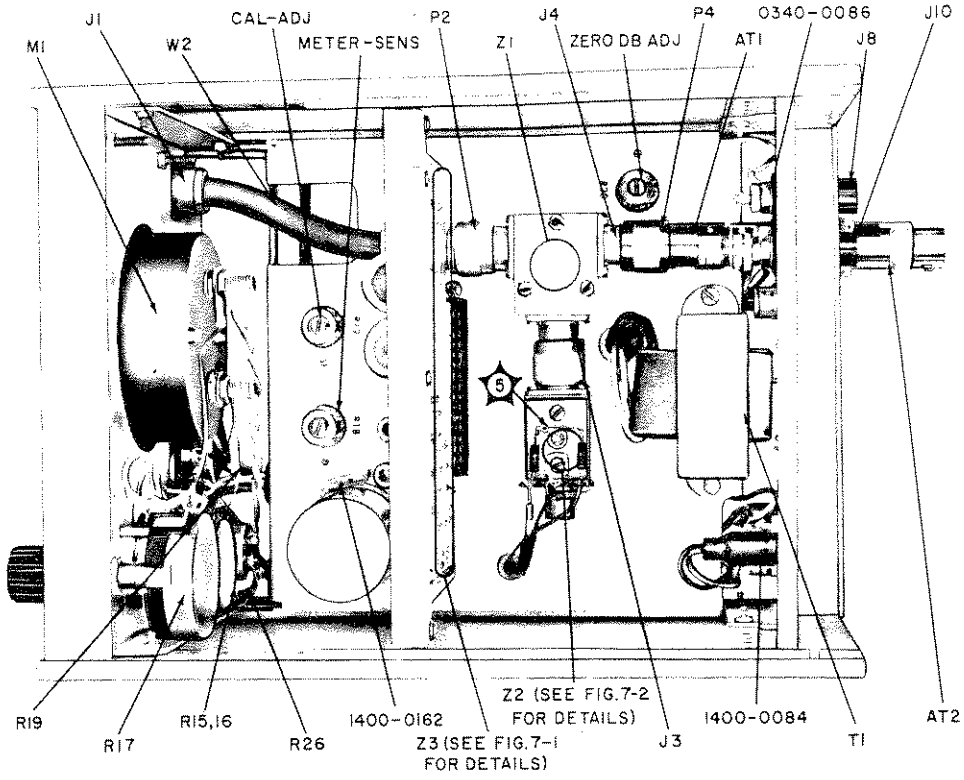

Fig. 6-1. 8900B Top View

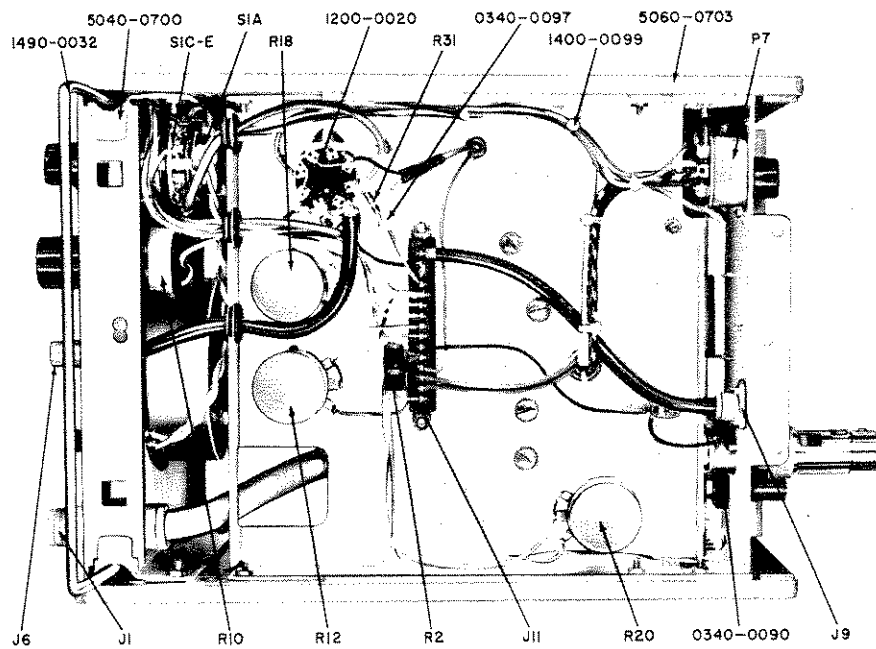
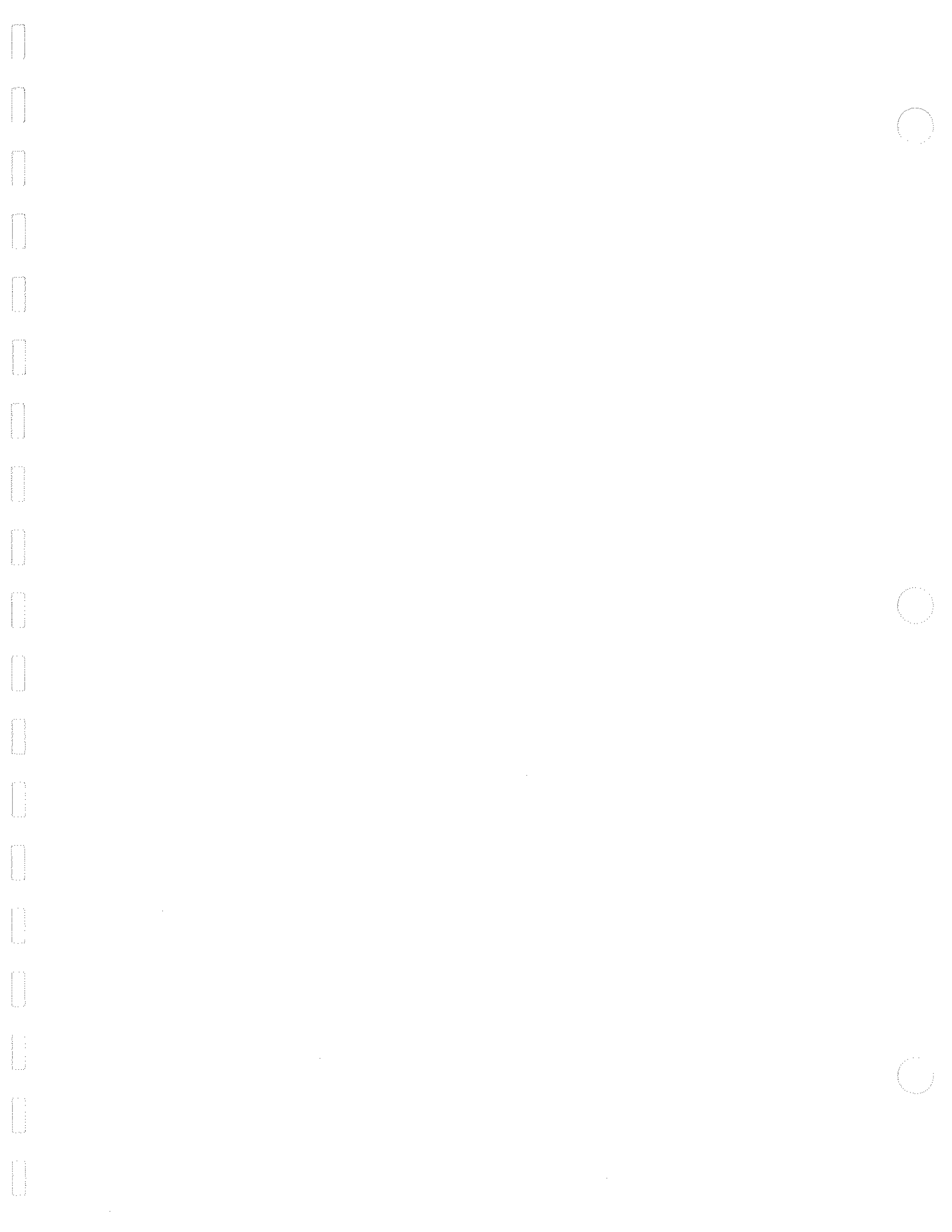

Fig. 6-2. 8900B Bottom View



SECTION VII

MAINTENANCE DATA

7-1. INTRODUCTION

7-2. This section provides the electrical circuit details in the form of schematics, diagrams, typical voltage and resistance readings, etc. for maintenance of the 8900B.

7-3. PRINTED CIRCUIT BOARD DIAGRAM

7-4. The Printed Circuit Board (Z3) diagram in Figure 7-1 shows all of the circuitry on both sides of the board with all of the electrical components. This diagram will provide the following facilities:

- a. Printed Circuit Board circuit tracing.
- b. Component replacement of polarized devices such as semiconductors, electrolytic capacitors, etc.

7-5. DETECTOR BLOCK DISASSEMBLY









7-6. An exploded view of the detector block assembly (Z2) is shown in Figure 7-2. The associated notes show specific details required for diode (CR5) replacement.

7-7. SCHEMATIC

7-8. A complete schematic for the 8900B is shown in Figure 7-3.

7-9. Schematic Notes.

- a. Resistance in ohms and capacitance in microfarads unless otherwise specified.
- b.  front panel designation

- c.  rear panel designation
- d.  front panel control
- e.  screwdriver adjustment
- f. CW clockwise end of variable resistor
- g.  dc reference path
- h.  demodulated RF path
- i. For fuse information, see paragraph 2-11.
- j. Numbers shown in parentheses indicate wire color using RETMA Resistor Color Code, e.g., Black-Red is (0·2)
- k.  test point - circuit board connection point.
- l.  test point
- m.  printed circuit board assembly

7-10. Voltage and Resistance Readings

7-11. Voltage and Resistance Readings shown in this section were measured with an -hp-410C- electronic voltmeter. These readings are typical except as noted in adjustment or calibration procedures of Section V.

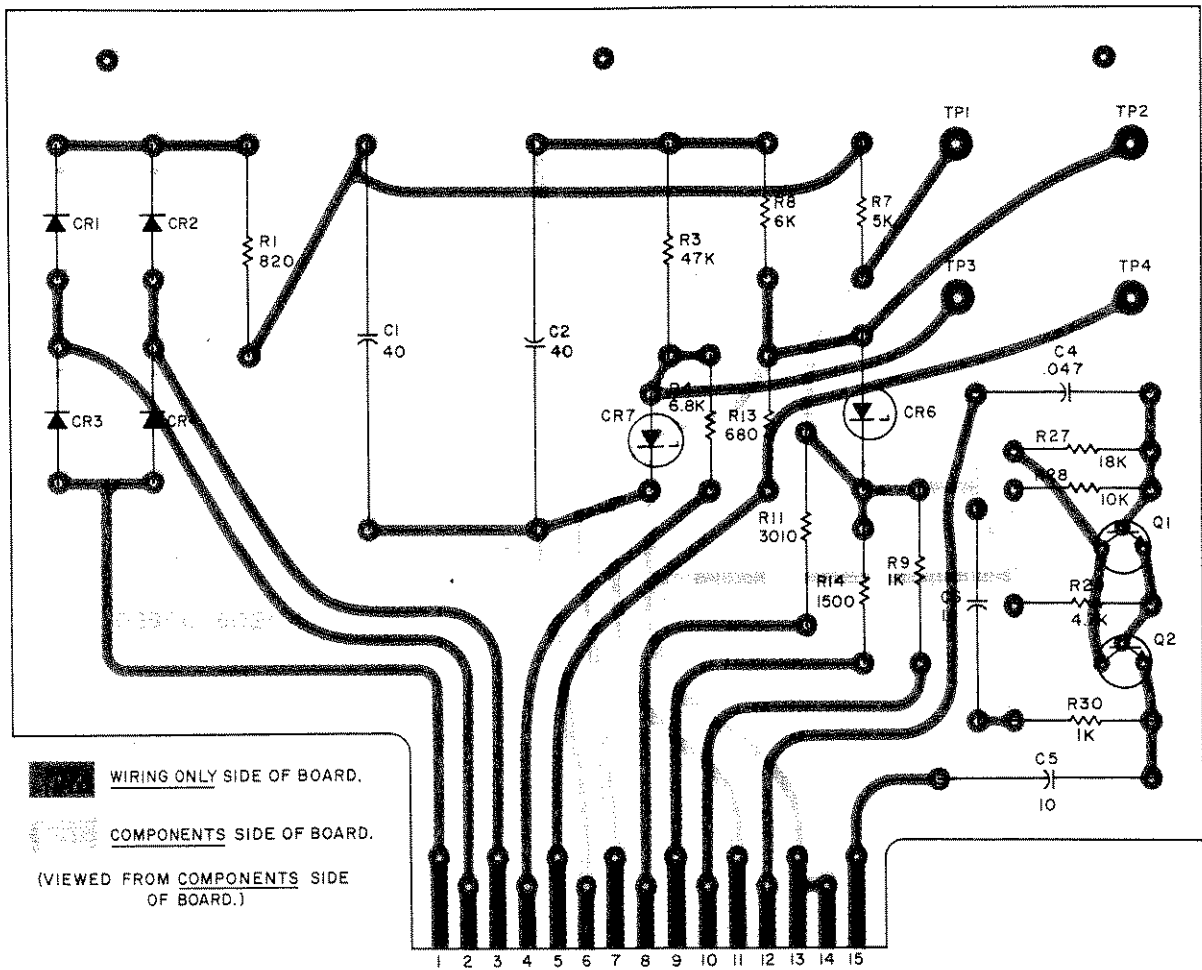

Figure 7-1. Printed Circuit Board Diagram

SALES AND SERVICE OFFICES

UNITED STATES and CANADA

ALABAMA

Huntsville, 35802
2003 Byrd Spring Rd. S.W.
(205) 881-4591
TWX: 510-579-2204

ALASKA

Bellevue, Wash. 98004
11656 N.E. 8th Street
(206) 454-3971
TWX: 910-443-2303

ARIZONA

Scottsdale, 85251
3009 No. Scottsdale Rd.
(602) 945-7601
TWX: 602-949-0111

Tucson, 85716
232 So. Tucson Blvd.
(602) 623-2564
TWX: 602-792-2759

CALIFORNIA

North Hollywood, 91604
3939 Lankershim Blvd.
(213) 877-1282 and 766-3811
TWX: 910-499-2170

Sacramento, 95821
2591 Carlsbad Ave.
(916) 482-1463
TWX: 916-444-8683

San Diego, 92106
1055 Shafter Street
(714) 223-8103
TWX: 714-276-4263

Palo Alto, 94303
1101 Embarcadero Rd.
(415) 327-6500
TWX: 910-373-1280

COLORADO

Englewood, 80110
7965 East Prentice
(303) 771-3455
TWX: 910-935-0705

CONNECTICUT

Middletown, 06457
589 Saybrook Rd.
(203) 346-6611
TWX: 710-428-2036

FLORIDA

Miami, 33125
2907 Northwest 7th St.
(305) 635-6461

Orlando, 32803
621 Commonwealth Ave.
(305) 425-5541
TWX: 305-841-2568

St. Petersburg, 33708
410-150th Ave., Madeira Beach
(813) 391-0211 and 391-1829
TWX: 813-391-0666

GEORGIA

Atlanta, 30305
3110 Maple Drive, N.E.
(404) 233-1141
TWX: 810-751-3283

HAWAII

North Hollywood, Calif. 91604
3939 Lankershim Blvd.
(213) 877-1282
TWX: 910-499-2170

ILLINOIS

Skokie, 60076
5500 Howard Street
(312) 677-0400
TWX: 910-223-3613

INDIANA

Indianapolis, 46205
3919 Meadows Dr.
(317) 546-4891
TWX: 317-635-4300

LOUISIANA

New Orleans
(504) 522-4359

MARYLAND

Baltimore, 21207
6660 Security Blvd.
(301) 944-5400
TWX: 710-862-0850

Rockville, 20852
12303 Twinbrook Pkwy.
(301) 427-7560
TWX: 710-828-9684

MASSACHUSETTS

Burlington, 01803
Middlesex Turnpike
(617) 272-9000
TWX: 710-332-0382

MICHIGAN

Southfield, 48076
24315 Northwestern Hwy.
(313) 353-9100
TWX: 313-357-4425

MINNESOTA

St. Paul, 55114
2459 University Ave.
(612) 646-7881
TWX: 910-563-3734

MISSOURI

Kansas City, 64114
9208 Wyoming Place
(816) 333-2445
TWX: 910-771-2087

St. Louis, 63144
2812 South Brentwood Blvd.
(314) 644-0220
TWX: 910-760-1670

NEW JERSEY

Eatontown, 07724
(201) 747-1060

Englewood, 07631
391 Grand Avenue
(201) 567-3933
TWX: 510-230-9709

NEW MEXICO

Albuquerque, 87108
6501 Lomas Blvd., N.E.
(505) 255-5586
TWX: 910-989-1655

Las Cruces, 88001
114 S. Water Street
(505) 526-2486
TWX: 910-983-0550

NEW YORK

New York, 10021
236 East 75th Street
(212) 879-2023
TWX: 710-581-4376

Rochester, 14623
39 Saginaw Drive
(716) 473-9500
TWX: 510-253-5981

Poughkeepsie, 12601
82 Washington Street
(914) 454-7330
TWX: 914-452-7425

Syracuse, 13211
5858 East Molloy Rd.
(315) 454-2486
TWX: 710-541-0482

Endicott, 13764
1219 Campville Rd.
(607) 754-0050
TWX: 510-252-0890

NORTH CAROLINA

High Point, 27262
1923 N. Main Street
(919) 882-6873
TWX: 510-926-1516

OHIO

Cleveland, 44129
5579 Pearl Road
(216) 884-9209
TWX: 216-888-0715

Dayton, 45409
1250 W. Dorothy Lane
(513) 298-0351
TWX: 513-944-0090

OKLAHOMA

Oklahoma City
(405) 235-7062

PENNSYLVANIA

Camp Hill
(717) 737-6791

West Conshohocken, 19428
144 Elizabeth Street
(215) 248-1600 and 828-6200
TWX: 518-660-8715

Monroeville, 15146
Monroe Complex
Building 2
Suite 2
Mass Side Blvd.
(412) 271-5227
TWX: 710-797-3650

TEXAS

Dallas, 75209
P.O. Box 7166, 3605 Inwood Rd.
(214) 357-1881
TWX: 910-861-4081

Houston, 77027
P.O. Box 22813, 4242 Richmond Ave.
(713) 667-2407
TWX: 713-571-1353

UTAH

Salt Lake City, 84115
1482 Major St.
(801) 486-8166
TWX: 801-521-2604

VIRGINIA

Richmond, 23230
2112 Spencer Road
(703) 282-5451
TWX: 710-956-0157

WASHINGTON

Bellevue, 98004
11656 N.E. 8th St.
(206) 454-3971
TWX: 910-443-2303

GOVERNMENT CONTRACTING OFFICE

San Antonio, Texas 78226
Hewlett-Packard
Contract Marketing Division
225 Billy Mitchell Road
(512) 434-4171
TWX: 512-571-0955

CANADA

Montreal, Quebec
Hewlett-Packard (Canada) Ltd.
8270 Mayrand Street
(514) 735-2273
TWX: 610-421-3484
Telex: 01-2819

Ottawa, Ontario
Hewlett-Packard (Canada) Ltd.
1762 Carling Avenue
(613) 722-4223
TWX: 610-562-1952

Toronto, Ontario
Hewlett-Packard (Canada) Ltd.
1415 Lawrence Avenue West
(416) 249-9196
TWX: 610-492-2382

Vancouver, B.C.
Hewlett-Packard (Canada) Ltd.
2184 W. Broadway
(604) 738-7520
TWX: 610-922-5059

SALES AND SERVICE OFFICES INTERNATIONAL - Electronic Equipment

ARGENTINA

Mauricio A. Suarez
Telecomunicaciones
Carlos Calvo 224
Buenos Aires
Tel. (30-6312) (34-9087)

AUSTRALIA

Sample Electronics (Vic) Pty., Ltd.
9-11 Cremorne Street
Richmond E.1, Victoria
Tel. 42-4757

Sample Electronics (N.S.W.) Pty. Ltd.
4 Grose Street
Glebe, New South Wales
Tel. 69-6338

AUSTRIA

Unilabor H.m.b.H.
Wissenschaftliche Instrumente
Rummelhardtgasse 6/3
P.O. Box 35, Vienna IX/71
Tel. 425 181

BELGIUM

Hewlett-Packard Benelux S.A.
20-24 rue de l'Hopital
Brussels
Tel. 11 22 20

BRAZIL

Ciental Importacao e Comercio Ltda.
Rua des Eliseu Guilherme, 62
Sao Paulo 8
Tel. 70-2318

CHILE

Hector Calcagni
Casilla 13942
Santiago
Tel. 6.42.26

DENMARK

Tage Oisen A/S
Ronnegade 1
Copenhagen 0
Tel. 29 48 00

FINLAND

INTO O/Y
Meritullinkatu 11
P.O. Box 153
Helsinki
Tel. 6 11 33

FRANCE

Hewlett-Packard France
150 Boulevard Massena
Paris 13
Tel. 707 97 19

Hewlett-Packard France
2 rue Tete d'Or
Lyon, 6 - Rhone
Tel. 52 35 66

GERMANY

Hewlett-Packard Vertriebs-GmbH
Kurfurstenstrasse 95
Frankfurt a. Main
Tel. 52 00 36

Hewlett-Packard Vertriebs-GmbH
Reginfriedstrasse 13, Munich 9
Tel. 49 51 21

Hewlett-Packard Vertriebs-GmbH
Beim Strohhause 26/28
Hamburg 1
Tel. 24 05 51

Hewlett-Packard Vertriebs-GmbH
(Technisches Buro)
Herrenberger Strasse 110
Böblingen, Württemberg
Tel. 6971

Hewlett-Packard Vertriebs-GmbH
Lietzenburger Strasse 30
1 Berlin W 30
Tel. 24 86 36

Hewlett-Packard Vertriebs-GmbH
Achenbachstrasse 15
4 Dusseldorf 1,
Tel. 68 52 58

GREECE

K. Karayannis
Klafiomonos Square
Athens 124
Tel. 230 301

INDIA

The Scientific Instrument Co., Ltd.
6, Tej Bahadur Sapru Road
Allahabad 1
Tel. 2451

The Scientific Instrument Co., Ltd.
240, Dr. Dadabhai Naoroji Road
Bombay 1
Tel. 26-2642

The Scientific Instrument Co., Ltd.
11 Esplanade East, Calcutta 1
Tel. 23-4129

The Scientific Instrument Co., Ltd.
30 Mount Road, Madras 1
Tel. 86339

The Scientific Instrument Co., Ltd.
B-7, Ajmeri Gate Extn.
New Delhi 1
Tel. 271053

IRAN

Telecom, Ltd.
P.O. Box 1812
Teheran
Tel. 43850, 48111

ISRAEL

Electronics & Engineering Ltd.
Division of Motorola Israel Ltd.
16, Kremenetski Street, Tel-Aviv
Tel. 35021

ITALY

Hewlett-Packard Italiana S.p.A.
Viale Lunigiana 46, Milan
Tel. 69 15 84

Hewlett-Packard Italiana S.p.A.
Palazzo Italia
Piazza Marconi 25, Rome-Eur
Tel. 591 2544

JAPAN

Yokogawa-Hewlett-Packard Ltd.
59, 1-chome
Yoyogi
Shibuya-ku
Tokyo,
Tel. 370-2281

Yokogawa-Hewlett-Packard Ltd.
8, Umeida
Kita-ku, Osaka City
Tel. 313-0091

Yokogawa-Hewlett-Packard Ltd.
4, 3-chome
Himerkedori
Chigusa-ku, Nagoya City
Tel. 751-8545

KOREA

American Trading Co., Korea, Ltd.
Seoul P.O. Box 1103
112-35 Sowong-Dong
Jung-ku, Seoul
Tel. 3.7049, 3.7613

LEBANON

Constantin E. Macridis
Clemenceau Street
Clemenceau Center
Beirut
Tel. 220846

NETHERLANDS

Hewlett-Packard Benelux, N.V.
23 Burg, Roelstraat
Amsterdam, W.
Tel. (020) 13 28 98

NEW ZEALAND

Sample Electronics (N.Z.) Ltd.
8 Matipo Street
Onehunga S.E. 5, Auckland
Tel. 565-361

NORWAY

Morgenstjerne & Co. A/S
Ingeniørfirma
6 Wessels Gate, Oslo
Tel. 20 16 35

PAKISTAN

Mushko & Company, Ltd.
Osman Chambers
Victoria Road
Karachi 3, West Pakistan
Tel. 54601

Mushko & Company, Ltd.
Zirat Chambers
31, Jinnah Avenue
Dacca, East Pakistan
Tel. 80058

PANAMA

Electronico Balboa, S.A.
P.O. Box 4929
Panama City
Tel. 3-0833

PERU

Fernando Ezeta B
Av. Petit Thouars 4719
Mira Flores, Lima
Tel. 5-0346

PORTUGAL

Telectra
Rua Rodrigo da Fonseca 103
P.O. Box 2531, Lisbon 1
Tel. 68 60 72

PUERTO RICO

San Juan Electronics, Inc.
Ponce de Leon No. 150, Stop 3
Pta. de Tierra Sta., San Juan
Tel. 725-3342

SPAIN

Ataio Ingenieros
Enrique Laretta 12
Madrid, 16
Tel. 235 43 44-5

SOUTH AFRICA

F.H. Flanter & Co. (Pty.), Ltd.
Rosella House
Buttercingle Street
Cape Town
Tel. 3-3817

F.H. Flanter & Co. (Pty.), Ltd.
P.O. Box 200, Bramley
775 Pretoria Main Road
Wynberg, Transvaal
Tel. 40-6871

SWEDEN

HP Instrument AB
Centralvagen 28
Solna Centrum
Tel. 08-83 08 30

HP Instrument AB
Box 4628
Incunagatan 28A
Möndal 4
Tel. 27 68 00

SWITZERLAND

Max Paul Frey
Wankdorffeldstrasse 66
Berne
Tel. (031) 42 00 78

TAIWAN

Hwa Sheng Electronic Co., Ltd.
P.O. Box 1558
21 Nanking West Road
Taipei
Tel. 46076, 45936

TURKEY

Telekom Engineering Bureau
P.O. Box 376 - Galata
Istanbul
Tel. 49 40 40

UNITED KINGDOM

Hewlett-Packard Ltd.
Dallas Road
Bedford, England
Tel. 68052

VENEZUELA

Citec, C.A.
Edif. Arisan-Of. No. 4
Avda. Francisco de Miranda
Chacaito
Caracas
Tel. 71.88.05

YUGOSLAVIA

Belram S.A.
83 Avenue des Mimosas
Brussels 15, Belgium
Tel. 35 29 58

For Sales and Service
Assistance in Areas Not
Listed Contact:

EUROPE

Hewlett-Packard, S.A.
54 Route des Acacias
Geneva, Switzerland
Tel. (022) 42.81.50

ELSEWHERE

Hewlett-Packard
1501 Page Mill Road
Palo Alto, California 94304, U.S.A.
Tel. (415) 326-7000